

Quantum Cube Model LaTeX Package (v0.1.0)

Cedric Schacht
cedric.schacht@uni.thm.de

June 2, 2025

Introduction

The **Quantum Cube Model (QCM)** package provides commands that make it easy to create diagrams representing the quantum cube model for up to 3 qubits. The package simplifies drawing complex quantum state diagrams inspired by Prof. B. Just's framework.

Requirements

To use this package include `\usepackage{quantumcubemodel}` in your documents preamble. This package depends on the following LaTeX packages:

```
\RequirePackage{braket}
\RequirePackage{xcolor}
\RequirePackage{tikz}
\usetikzlibrary{3d, calc, arrows.meta}
```

License

MIT License
Copyright (c) 2025 Cedric Schacht

Permission is hereby granted, free of charge, to any person obtaining a copy of this software and associated documentation files (the "Software"), to deal in the Software without restriction, including without limitation the rights to use, copy, modify, merge, publish, distribute, sublicense, and/or sell copies of the Software, and to permit persons to whom the Software is furnished to do so, subject to the following conditions:

The above copyright notice and this permission notice shall be included in all copies or substantial portions of the Software.

THE SOFTWARE IS PROVIDED "AS IS", WITHOUT WARRANTY OF ANY KIND, EXPRESS OR IMPLIED, INCLUDING BUT NOT LIMITED TO THE WARRANTIES OF MERCHANTABILITY, FITNESS FOR A PARTICULAR PURPOSE AND NONINFRINGEMENT. IN NO EVENT SHALL THE AUTHORS OR COPYRIGHT HOLDERS BE LIABLE FOR ANY CLAIM, DAMAGES OR OTHER LIABILITY, WHETHER IN AN ACTION OF CONTRACT, TORT OR OTHERWISE, ARISING FROM, OUT OF OR IN CONNECTION WITH THE SOFTWARE OR THE USE OR OTHER DEALINGS IN THE SOFTWARE.

References

Bettina Just. *Quantum Computing Compact: Spooky Action at a Distance and Teleportation Easy to Understand*. Berlin, Heidelberg: Springer, 2022. ISBN: 978-3-662-65007-3 978-3-662-65008-0. DOI: 10.1007/978-3-662-65008-0. URL: <https://link.springer.com/10.1007/978-3-662-65008-0> (visited on 05/26/2025)

Provided Commands

Draws a diagram for a **single qubit** with the specified quantum state.

```
\qcmQ{<amplitude>:<phase>}{<amplitude>:<phase>}
```

Draws a diagram for **two qubits** with the given specified quantum state.

```
\qcmQQ{<amplitude>:<phase>}
  {<amplitude>:<phase>}
  {<amplitude>:<phase>}
  {<amplitude>:<phase>}
```

Draws a diagram for **three qubits** with the given specified quantum state.

```
\qcmQQQ{<amplitude>:<phase>}
  {<amplitude>:<phase>}
  {<amplitude>:<phase>}
  {<amplitude>:<phase>}
  {<amplitude>:<phase>}
  {<amplitude>:<phase>}
  {<amplitude>:<phase>}
  {<amplitude>:<phase>}
```

Changes the scale of the generated diagrams (e.g., `\qcmScale{3}` is a good starting point).

Draws the wireframe of the transition diagram used in the quantum cube model. To be used inside a tikz environment.

```
\qcmWireframe{1} % for a single qubit
\qcmWireframe{2} % for two qubits
\qcmWireframe{3} % for three qubits
```

Transitions for frequently used Gates

```
\qcmTransitionHadamardQ{}
\qcmTransitionPauliXQ{}
\qcmTransitionPauliZQ{}
```

```
\qcmTransitionHadamardQQ{1 or 2}
\qcmTransitionPauliXQQ{1 or 2}
\qcmTransitionPauliZQQ{1 or 2}
\qcmTransitionCNOTQQ{1 or 2}{2 or 1}
```

```
\qcmTransitionHadamardQQQ{1 or 2 or 3}
\qcmTransitionPauliXQQQ{1 or 2 or 3}
\qcmTransitionPauliZQQQ{1 or 2 or 3}
\qcmTransitionCNOTQQQ{1 or 2 or 3}{2 or 3 or 1}
\qcmTransitionToffolieQQQ{1 or 2 or 3}{2 or 3 or 1}{3 or 1 or 2}
```

Usage Examples

Please visit <https://github.com/CedricSchacht/quantumcubemodel> for further example usages.

Single qubit system

```
\qcmQ{1:0}{0:0}
```

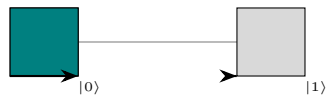

Figure 1: The $|0\rangle = 1 \cdot |0\rangle + 0 \cdot |1\rangle$ state

```
\def\qcmScale(5)  
\qcmQ{1:0}{0:0}
```

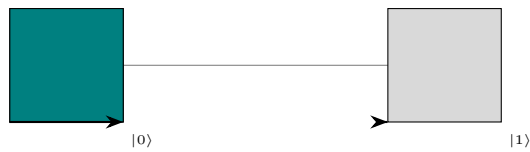

Figure 2: Make it bigger default is 3

```
\qcmQ{0:0}{1:0}
```



Figure 3: The $|1\rangle = 0 \cdot |0\rangle + 1 \cdot |1\rangle$ state

```
\qcmQ{0.5:0}{0.86:90}
```



Figure 4: Superposition state with phase on $|1\rangle$

Two qubit systems

`\qcmQQ{0.5:12}{0.5:180}{0:0}{0.71:40}`

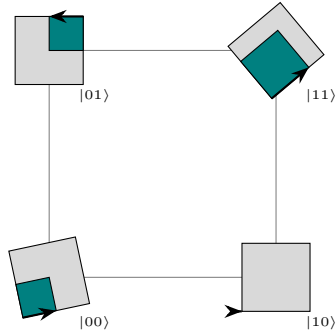

Three qubit systems

`\qcmQQQ{0.5:12}{0.5:180}{0:0}{0.71:40}`

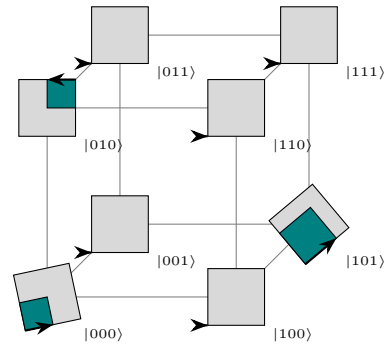

Full Diagram

```

\begin{figure}[htbp]
  \centering
  \begin{subfigure}[b]{0.4\textwidth}
    \def\qcmScale{2}
    \centering
    \qcmQQQ{1:0}{0:0}{0:0}{0:0}{0:0}{0:0}{0:0}{0:0}
    \caption{Initial state  $|\text{ket}\{000\}$ }
  \end{subfigure}%
  \begin{subfigure}[b]{0.2\textwidth}
    \centering
    \def\qcmScale{1}
    \qcmTransitionHadamardQQQ{1}
    \vspace*{1.5cm}
  \end{subfigure}%
  \begin{subfigure}[b]{0.4\textwidth}
    \def\qcmScale{2}
    \centering
    \qcmQQQ{0.71:0}{0:0}{0.71:0}{0:0}{0:0}{0:0}{0:0}{0:0}
    \caption{Terminal state  $\frac{1}{\sqrt{2}}(|\text{ket}\{000\} + |\text{ket}\{100\})$ }
  \end{subfigure}
  \caption{Effect of Hadamard on the first bit in a system of three}
\end{figure}

```

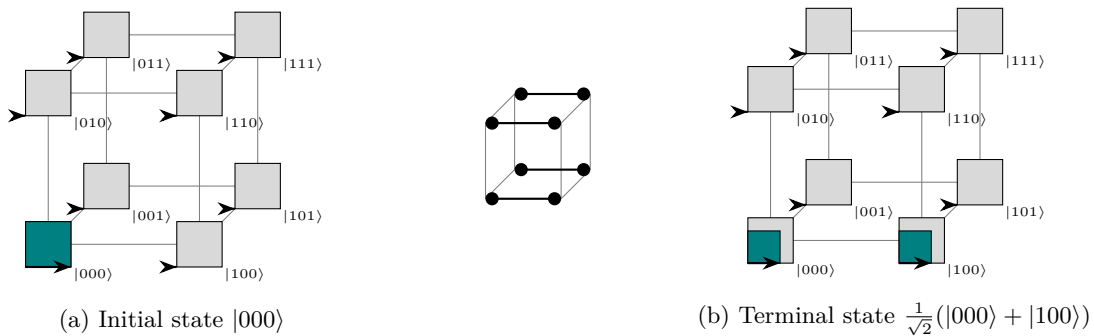

Figure 5: Effect of Hadamard on the first bit in a system of three

Transitions

For one Qubit systems use the `\qcmTransition<GateName>Q{}` commands

`\qcmTransitionHadamardQ{}`

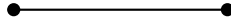

Figure 6: Transition diagram for Hadamard on a single Qubit

`\qcmTransitionPauliXQ{}`



Figure 7: Transition diagram for PauliX on a single Qubit

`\qcmTransitionPauliZQ{}`

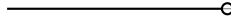

Figure 8: Transition diagram for PauliZ on a single Qubit

For two Qubit systems use the `\qcmTransition<GateName>QQ{<1> or <2>}` commands

`\qcmTransitionHadamardQQ{1}`

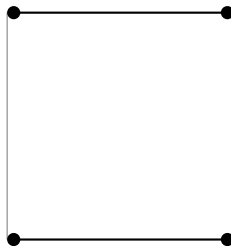

Figure 9: Transition diagram for Hadamard on the first of two Qubits

`\qcmTransitionPauliXQQ{2}`

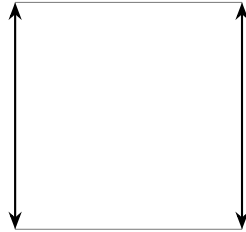

Figure 10: Transition diagram for PauliX on the second of two Qubits

`\qcmTransitionCNOTQQ{1}{2}`

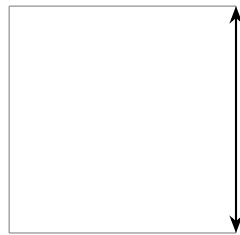

Figure 11: Transition diagram for CNOT with Control=1 and Target=2

`\qcmTransitionCNOTQQ{2}{1}`

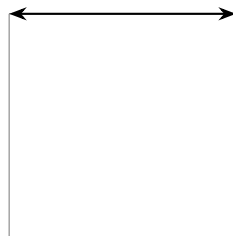

Figure 12: Transition diagram for CNOT with Control=2 and Target=1

\qcmTransitionHadamardQQQ{2}

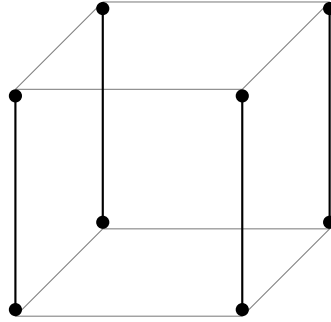

Figure 13: Transition diagram for Hadamard on the second of three Qubits

\qcmTransitionPauliXQQQ{3}

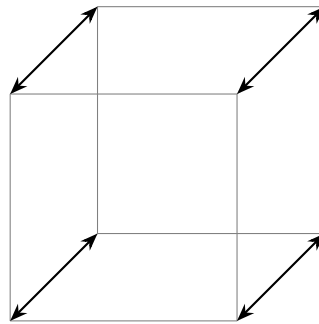

Figure 14: Transition diagram for PauliX on the third of three Qubits

\qcmTransitionCNOTQQQ{1}{2}

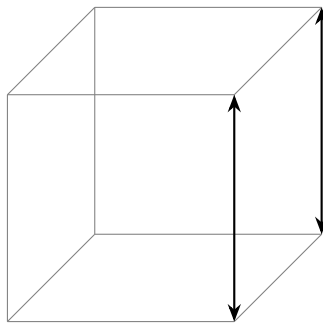

Figure 15: Transition diagram for CNOT with Control=1 and Target=2

`\qcmTransitionCNOTQQQ{3}{1}`

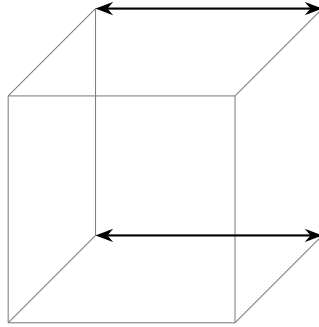

Figure 16: Transition diagram for CNOT with Control=3 and Target=1

`\qcmTransitionToffolieQQQ{1}{2}{3}`

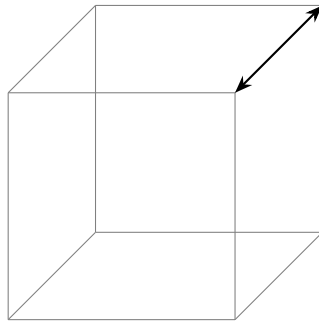

Figure 17: Transition diagram for CNOT with Control= 1 and 2 and Target=3

`\qcmTransitionToffolieQQQ{1}{3}{2}`

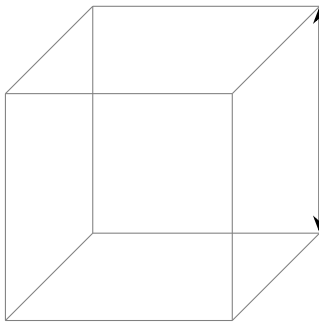

Figure 18: Transition diagram for CNOT with Control= 1 and 3 and Target=2